

Sākam mācīties!
Skaitļi un figūras

1 2 3 4

12. darba lapa

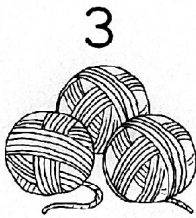
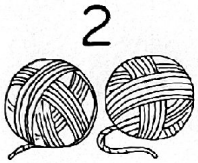
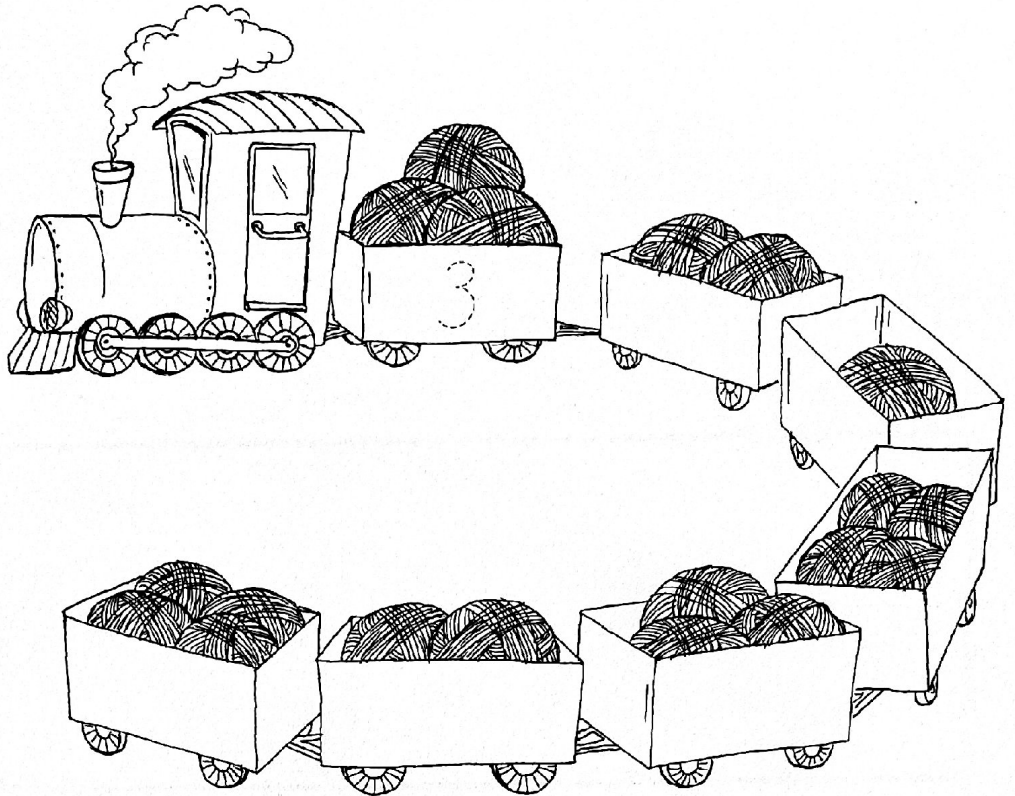
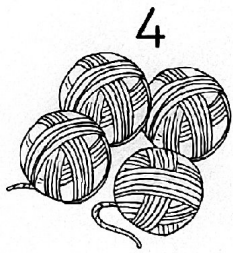

●	● ●	● ●	● ● ● ●	●	○ ○	○ ○ ○
	←					

Sākam mācīties!
Skaitļi un figūras

1	2	3	4				
---	---	---	---	--	--	--	--

1 2 3 4



12. darba lapa

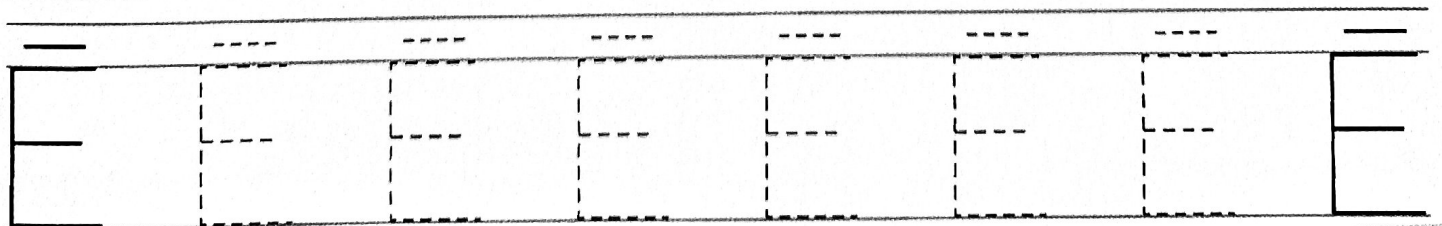
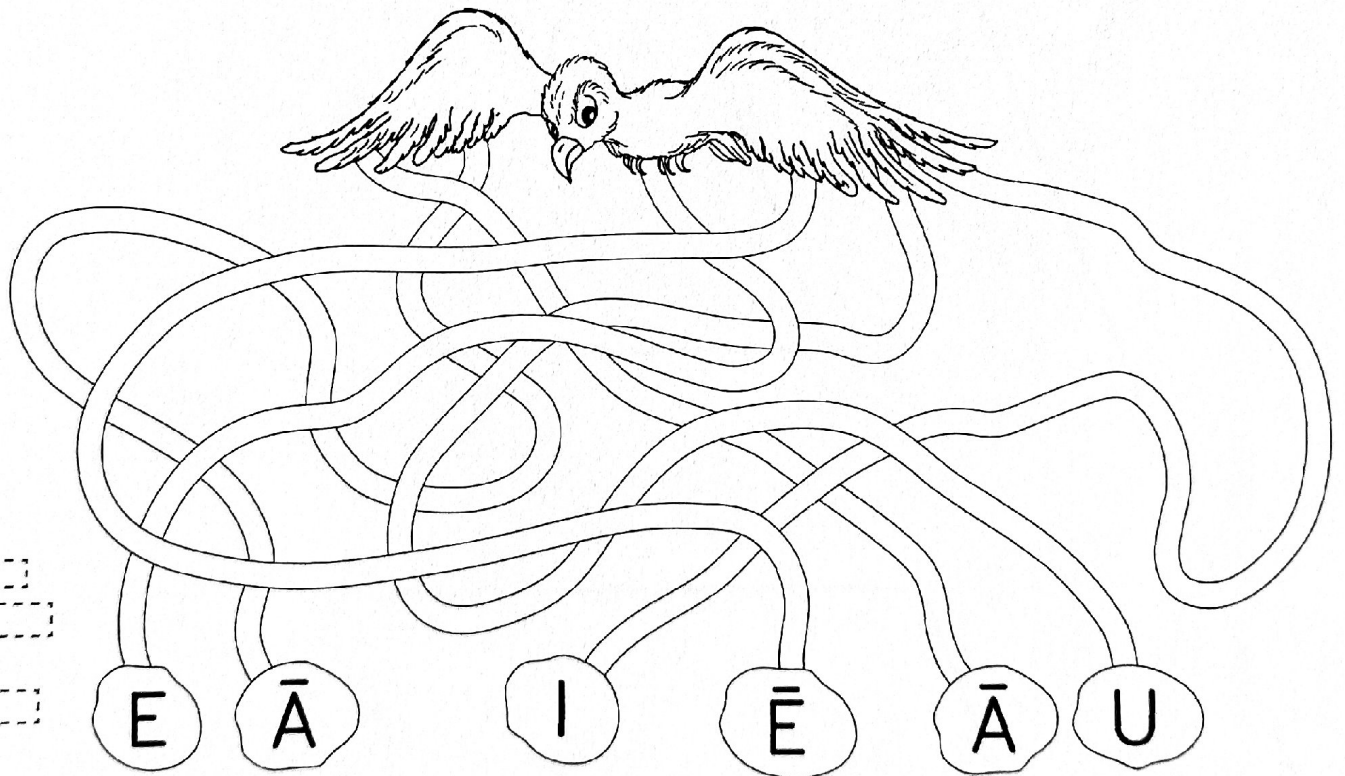
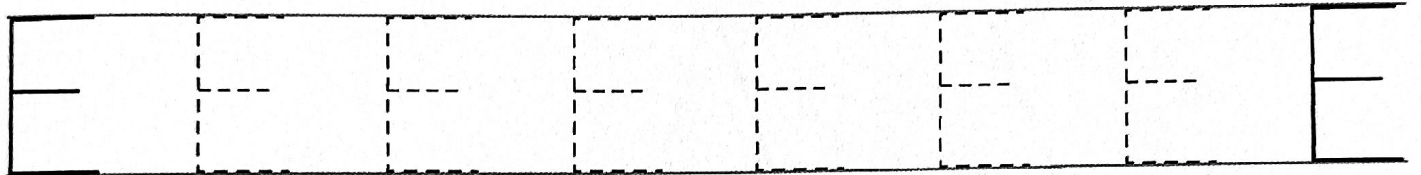
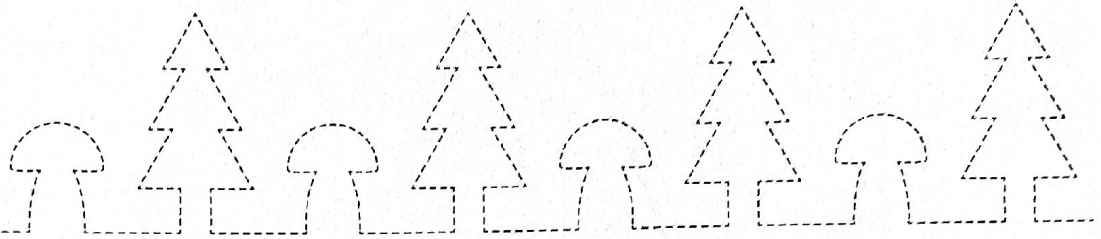
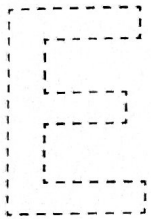
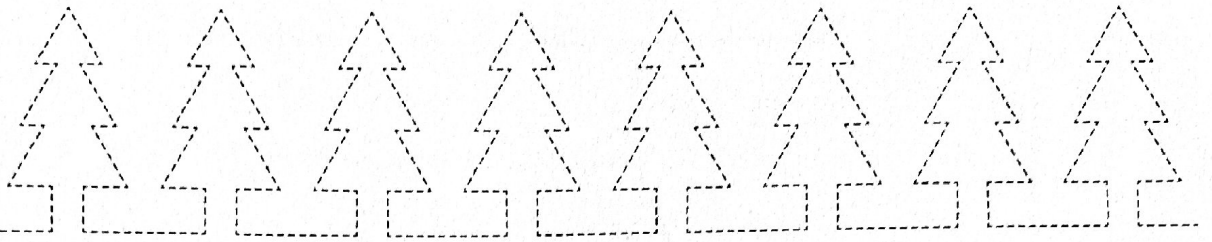
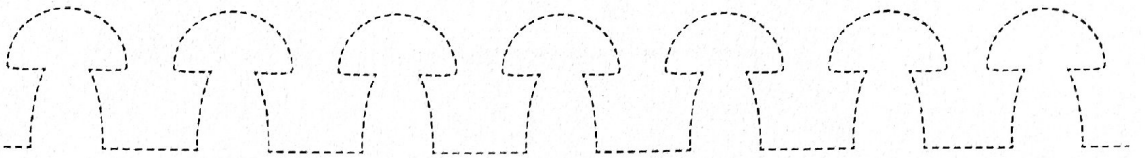

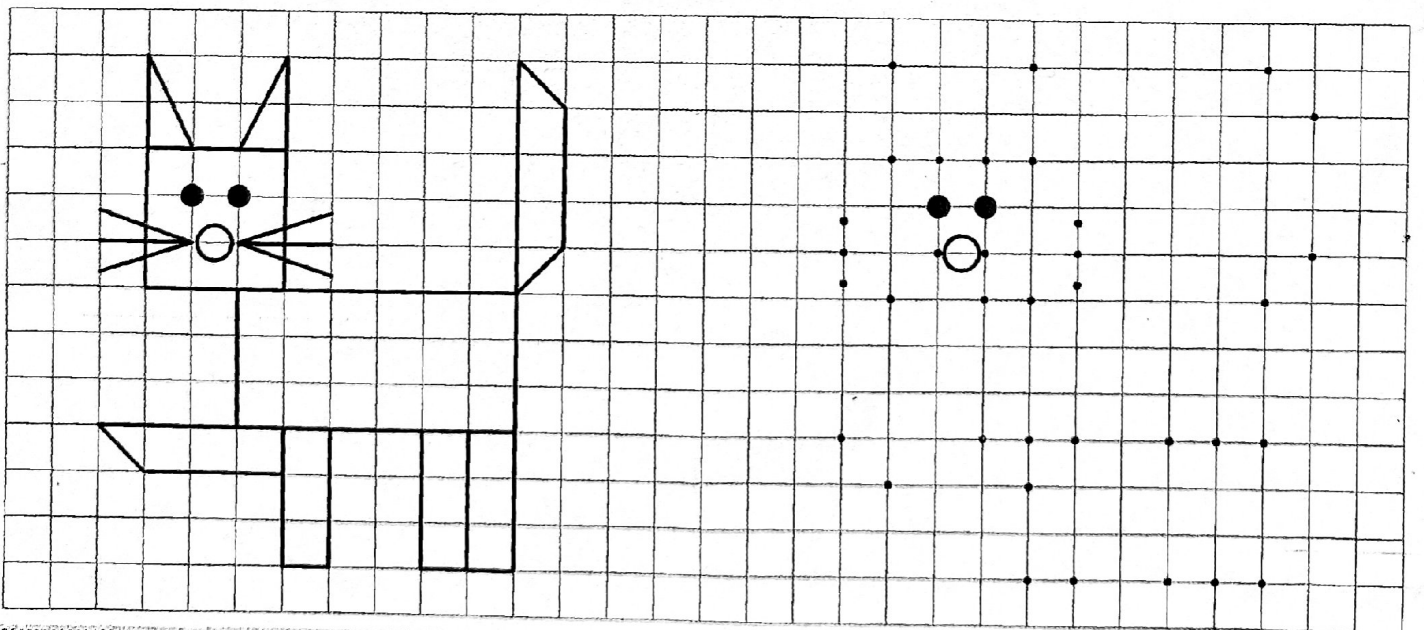
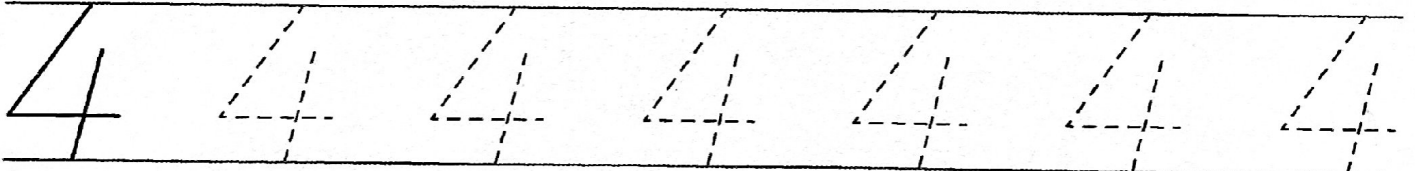
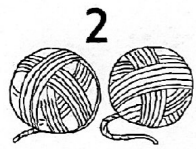
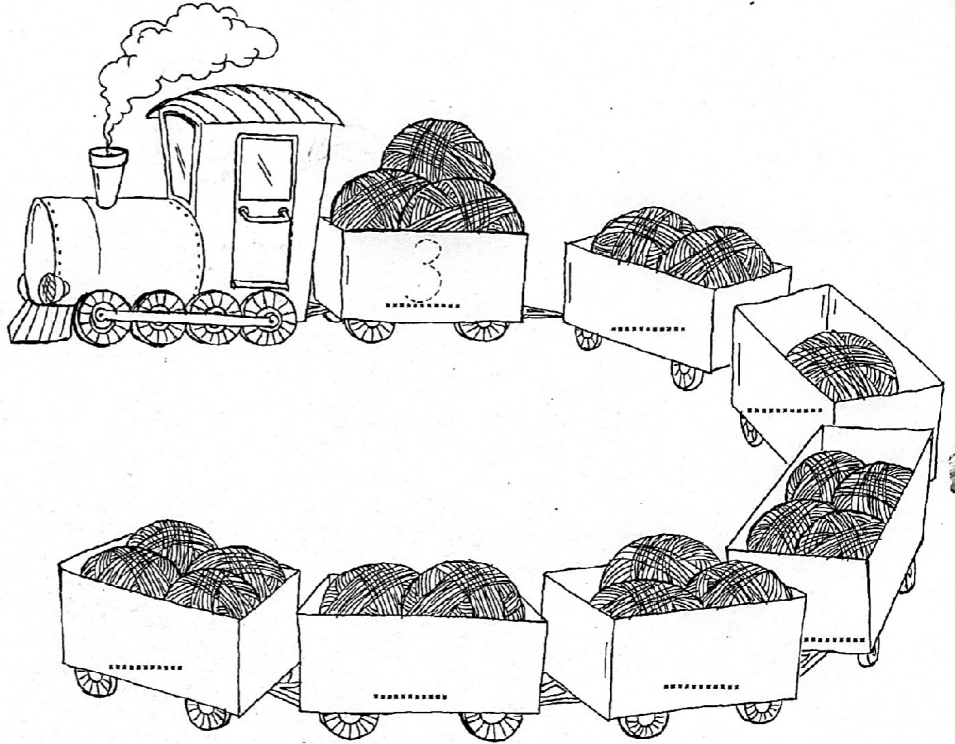
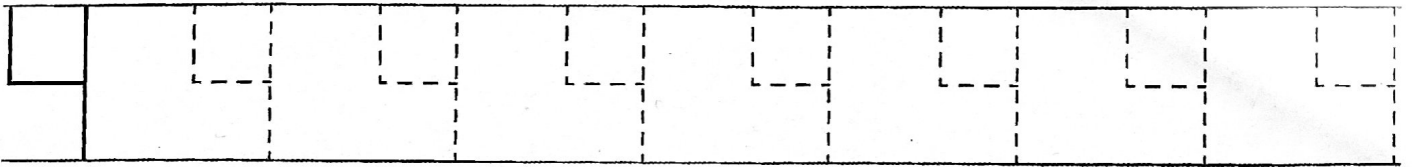

1 2 3 4

Pārvelc!

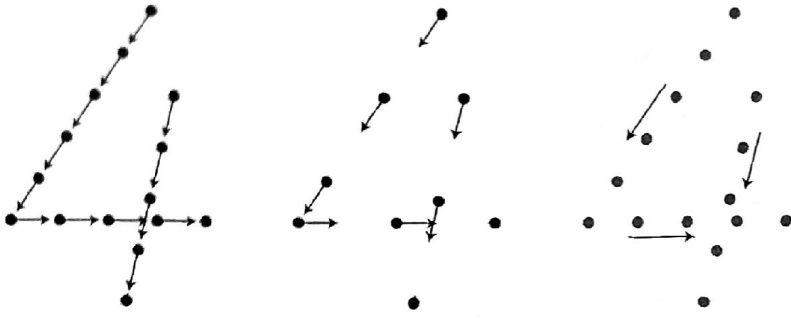

Raksti!

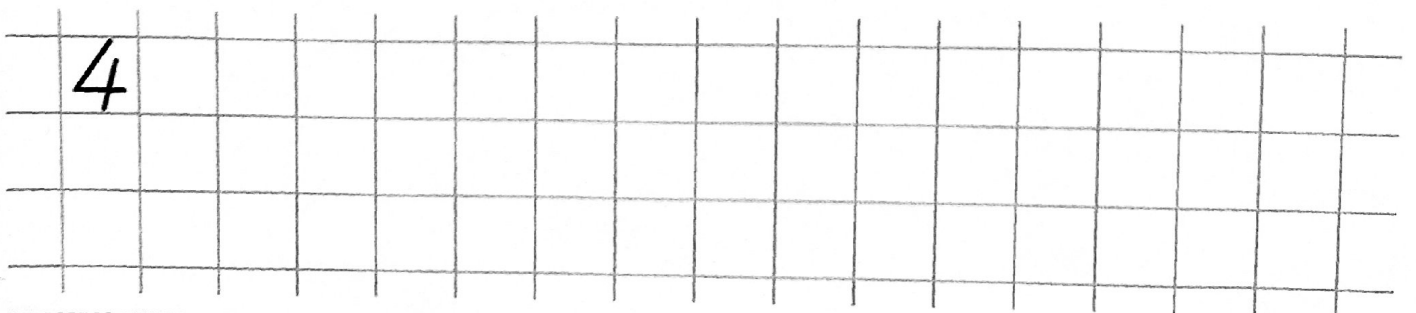
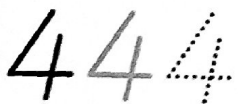
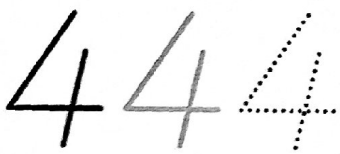
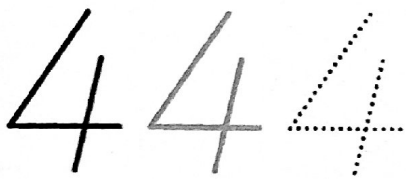
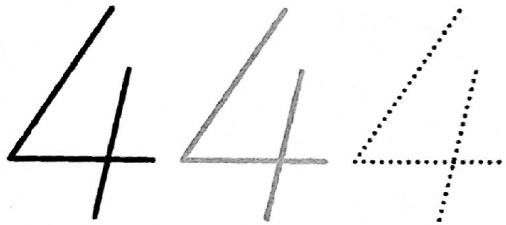

Es zinu, cik ir 4!

Rēķini! Savieno atbildi ar zīmējumu!

$1 + 1 = \boxed{2}$

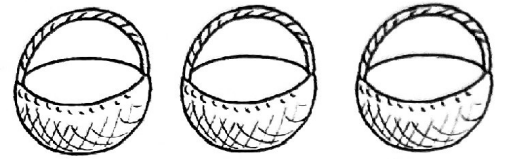

$2 + 1 = \boxed{}$

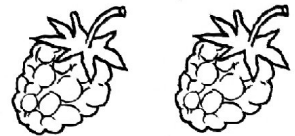

$3 + 1 = \boxed{}$

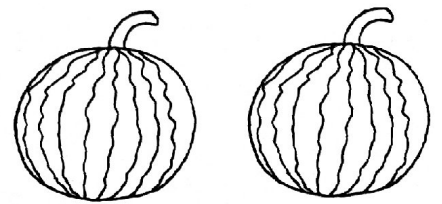

$2 + 2 = \boxed{}$

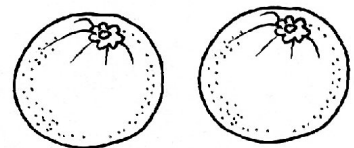

$1 + 2 = \boxed{}$

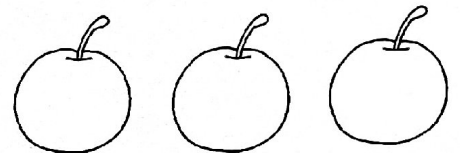

$3 - 1 = \boxed{}$



$2 - 1 = \boxed{}$

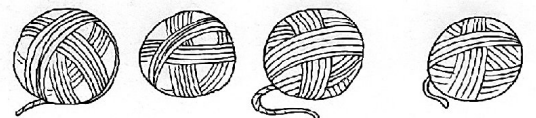

$4 - 1 = \boxed{}$

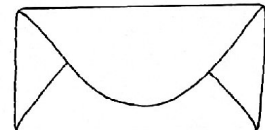

$4 - 2 = \boxed{}$



$4 - 3 = \boxed{}$

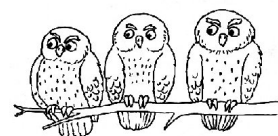

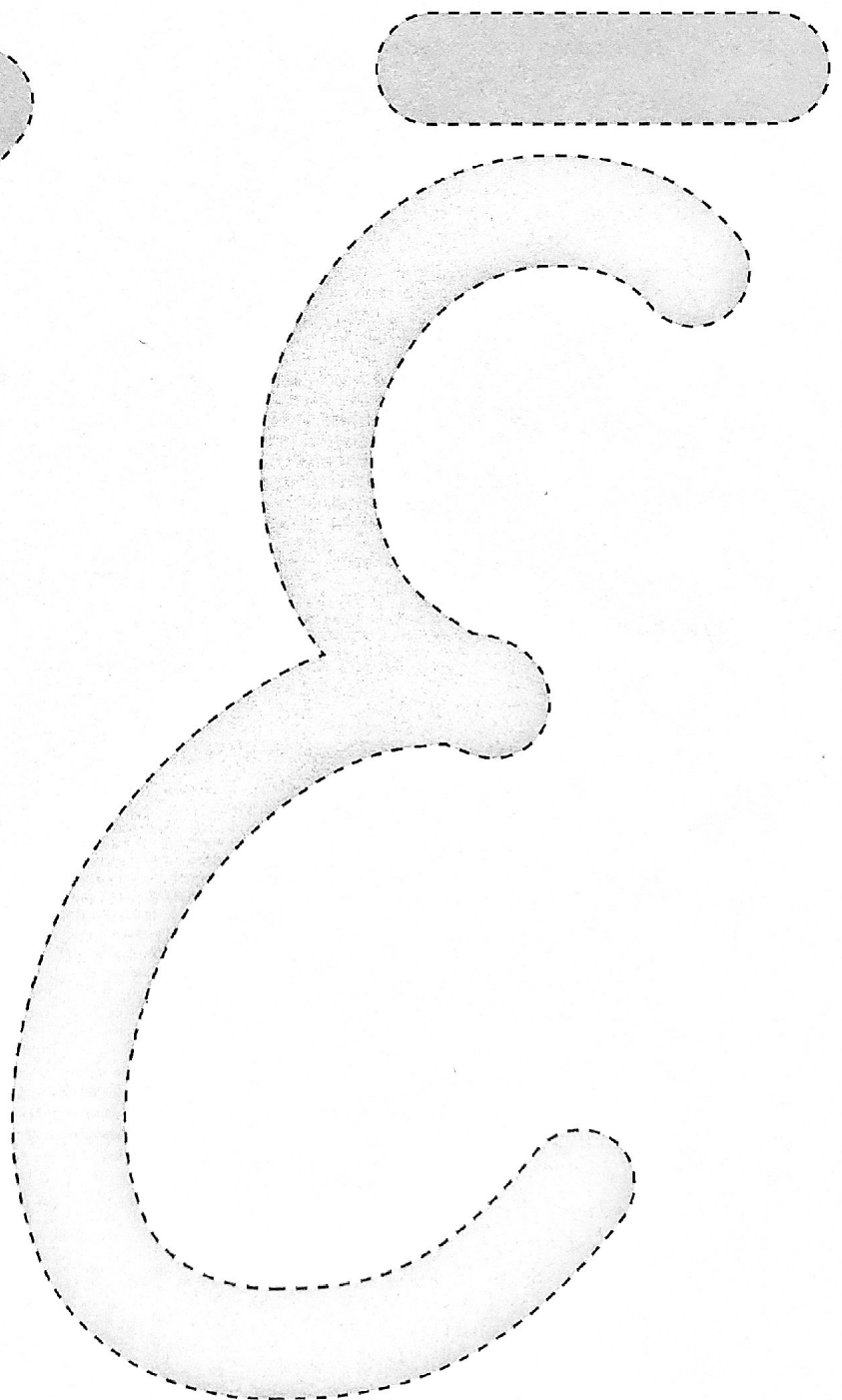
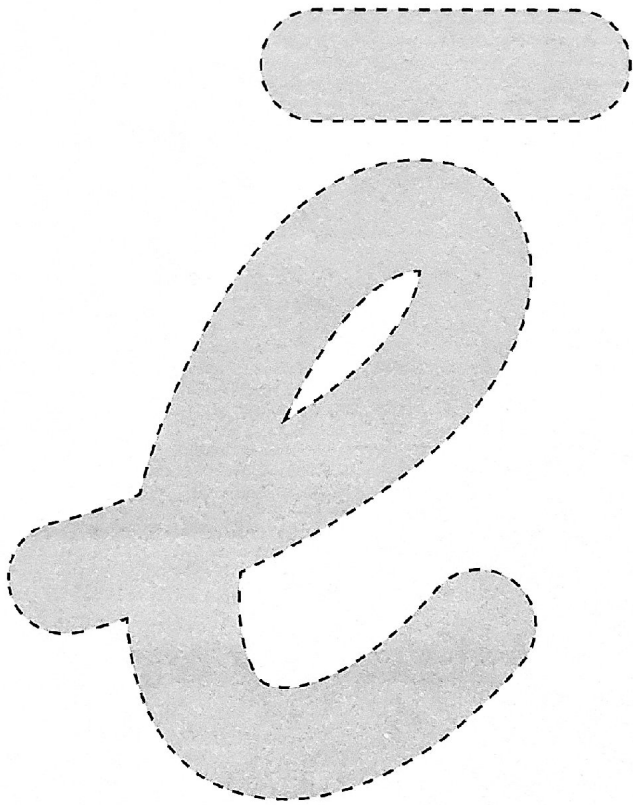

e, ē, E, Ē lasīšana un rakstīšana

Lasi!

e ē E Ē

Elīnai ēna.

e ē E Ē

Elīnai ēna.

Apvelc e, E, Ē un saskaiti!

Ella un Emīls dzīvo Ērgļos.
Elīna ar Elvi dodas ciemos
pie Ellas un Emīla.

E	<input type="text"/>
Ē	<input type="text"/>
e	<input type="text"/>

Ieraksti, uzzīmē, izkrāso!

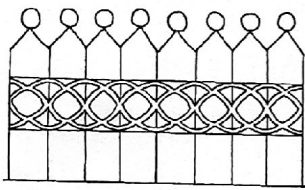

s t



z



z k

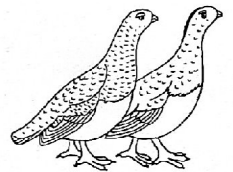

r b s

z s

Raksti!

e e e e

ē ē ē ē

E E E E

Ē Ē Ē Ē

Ceļš ar e, ē

Izej labirintu! Kam līdzīgs noietais ceļš?

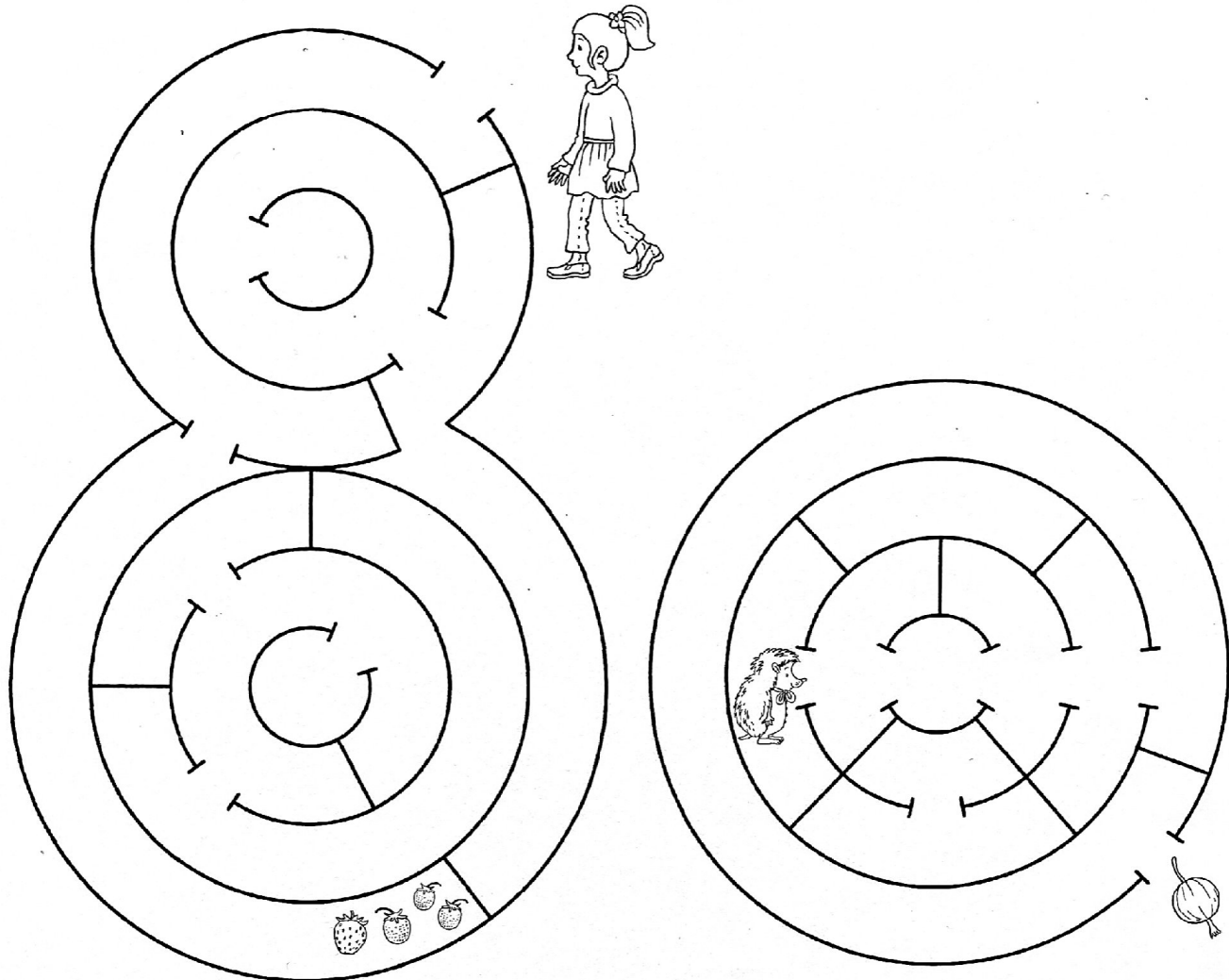

Pārvelc katra burta ceļu! Ieraksti riņķī pareizo burtu! Izlasi!

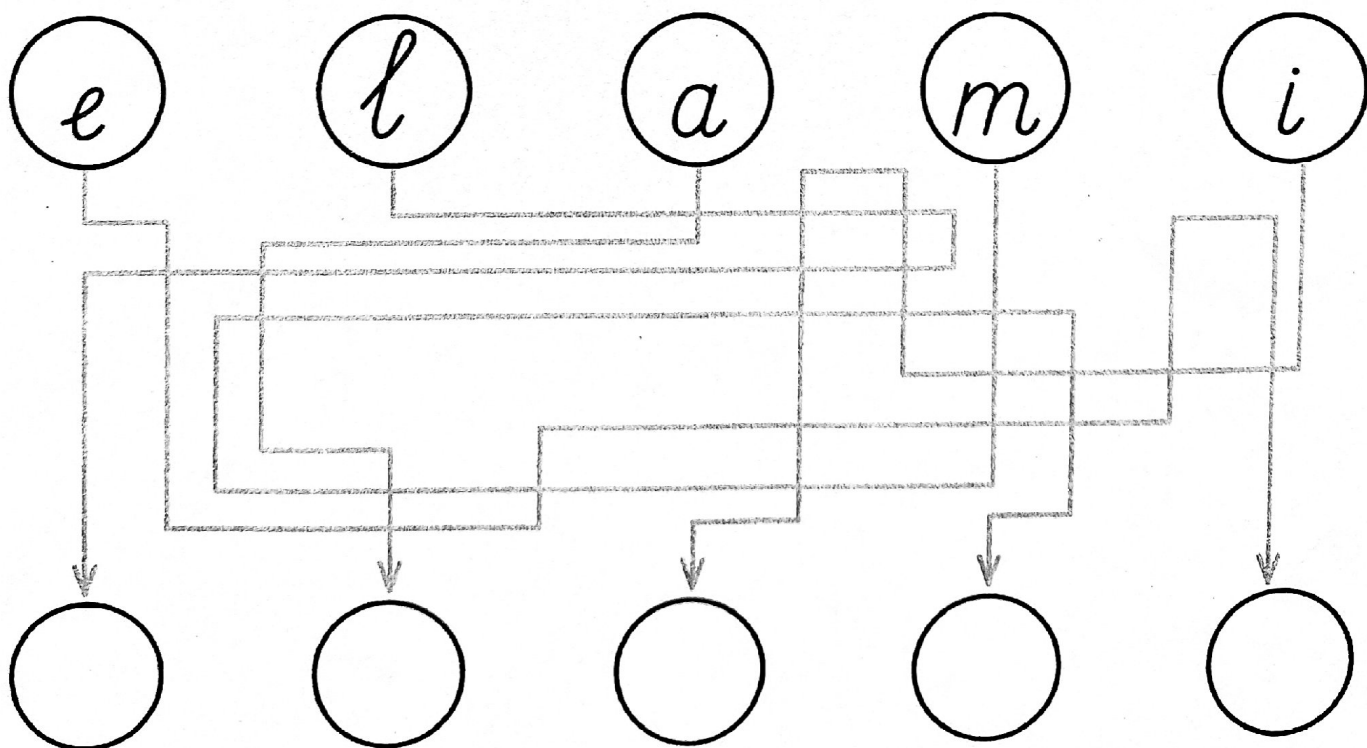

Burtu spēle ar e, ē

Runā un ieraksti burtus, kurus zini!



--	--	--	--	--	--

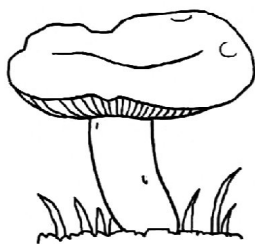

--	--	--	--	--

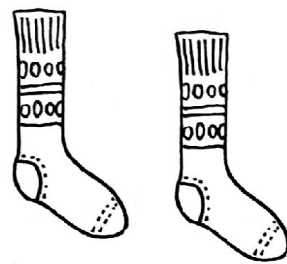

--	--	--	--	--	--



--	--	--	--	--



--	--	--	--	--

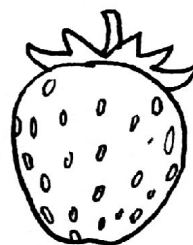

--	--	--	--	--	--

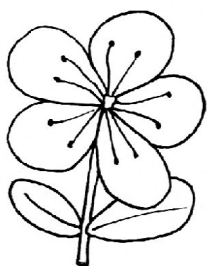

--	--	--	--	--

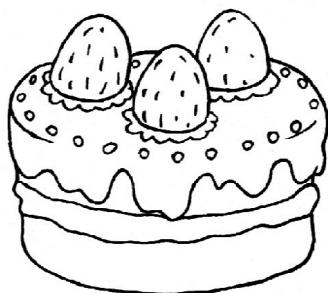

--	--	--	--	--	--



--	--	--	--	--	--

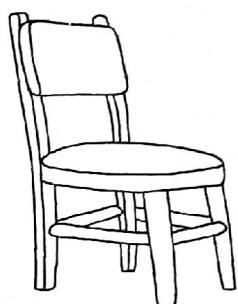

--	--	--	--	--	--	--



--	--	--	--	--	--	--

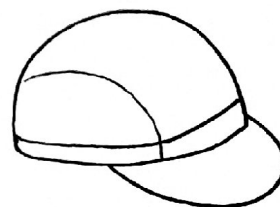

--	--	--	--	--	--	--